

INSTALLATION INSTRUCTION

Arc

WS-3326, WS-3328



MODERN FORMS
A WAC LIGHTING COMPANY

WARNING

IMPORTANT: NEVER attempt any work without shutting off the electricity.

- Read all instructions before installing.
- System is intended for installation by a qualified electrician in accordance with the National Electrical Code and local regulations.
- Go to the main fuse box, or circuit breaker. Place the main power switch in the "OFF" position and unscrew the fuse(s) or switch "OFF" the circuit breaker switch(es) that control the power to the fixture or room that you are working on.
- Place the wall switch in the "OFF" position.

CAUTION

- All parts must be used as indicated in these instructions. Do not substitute any parts, leave parts out, or use any parts that are worn out or broken. Failure to follow this instruction could invalidate the ETL/CETL listing of this fixture. CAUTION When handling the fixture, do not apply pressure to the LEDs. Hold the fixture by the base only.

AVERTISSEMENT

IMPORTANT : Coupez l'électricité avant TOUTE manipulation.

- Lisez toutes les instructions avant d'installer.
- Système est destiné à être installé par un électricien qualifié en conformité avec le code national de l'électricité et les règlements locaux.
- Accédez au panneau central de disjoncteurs ou de fusibles de votre demeure et placez l'interrupteur principal en position d'arrêt (« OFF »).
- Placez l'interrupteur mural en position d'arrêt (« OFF »).

MISE EN GARDE

- Toutes les pièces doivent être utilisées tel qu'il est indiqué dans ces instructions. Ne remplacez pas les pièces, n'en laissez pas de côté et ne les utilisez pas si elles sont usées ou brisées. Le non-respect de ces instructions peut annuler l'homologation ETL/CETL du luminaire. MISE EN GARDE Ors de la manipulation de l'appareil, ne pas appliquer de pression à la LED, tenir l'appareil par la seule base.

ADVERTENCIA









IMPORTANTE: NUNCA intente hacer trabajos sin desconectar el suministro eléctrico.

- Lea y comprenda todas las instrucciones e ilustraciones por completo antes de proceder con el ensamblaje e instalación de esta lámpara.
- Sistema está diseñado para ser instalado por un electricista calificado, de acuerdo con el código eléctrico nacional y las normas locales.
- Diríjase a la caja de fusibles o a la caja del interruptor de circuito principal en su hogar. Coloque el interruptor de alimentación principal en la posición "OFF" (APAGADO).
- Coloque el interruptor de la pared en la posición "OFF" (APAGADO).

PRECAUCIÓN

- Todas las piezas deben usarse como lo indican estas instrucciones. No reemplace las piezas, no omita piezas durante la instalación ni utilice piezas gastadas o rotas. El incumplimiento de esta indicación podría invalidar la calificación ETL/CETL esta lámpara. PRECAUCIÓN Al manipular el aparato, no aplique presión a los LED, mantenga el aparato en la base sólo.

HARDWARE

								
Wire Connector Qty: 3	Junction Box Screw Qty: 2+1 Extra	Mounting Screw Qty: 4+1 Extra	Glass Holder Qty: 2	Mounting Screw Qty: 2+1 Extra	Nut Qty: 4	Plastic Washer Qty: 4	Iron Washer Qty: 4	Mounting Ancher Qty: 2+1 Extra

Modern Forms

www.modernforms.com

Phone (800) 526.2588 • Fax (800) 526.2585

Headquarters/Eastern Distribution Center

44 Harbor Park Drive • Port Washington, NY 11050

Phone (516) 515.5000 • Fax (516) 515.5050

Western Distribution Center

1750 Archibald Ave • Ontario, CA 91761

Phone (800) 526.2588 • Fax (800) 526.2585



INSTALLATION INSTRUCTION

Arc
WS-3326, WS-3328



FIG.1

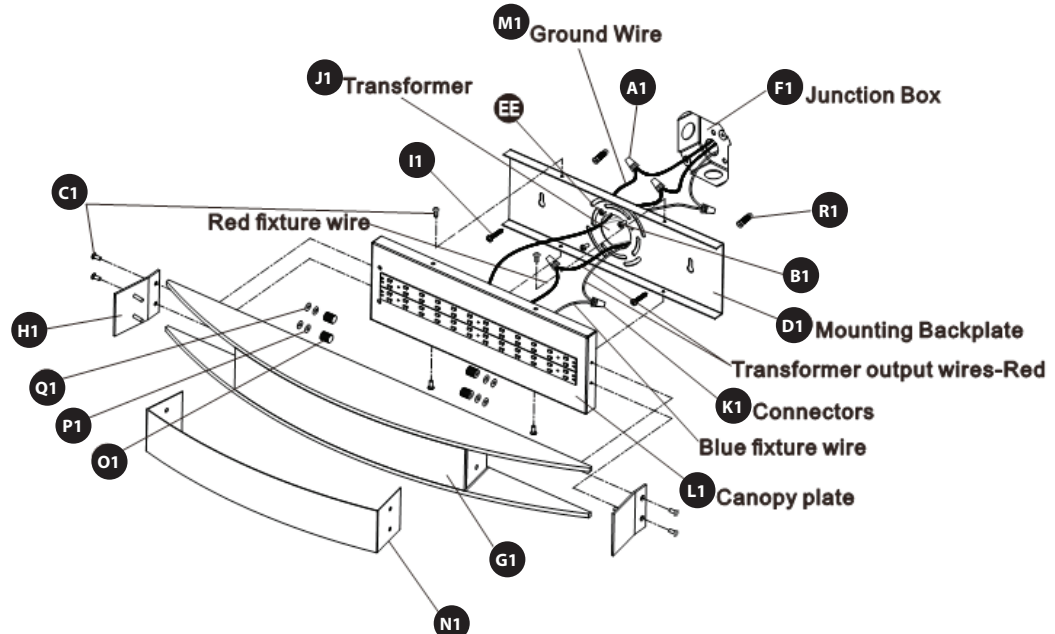

PREPARATION

1. Shut off the power at the circuit breaker and remove existing fixture, including the crossbar.
2. Carefully unpack your new fixture and lay out all the parts on a clear area. Be careful not to lose any small parts necessary for installation.

CONNECTING THE WIRES (Fig. 2)

3. Remove screws (C1) from the fixture and remove connectors (K1).
4. Connect the transformer input wires to junction box wires as shown in Fig. 2, making sure that all wire connectors (A1) are secured. If your outlet box has a ground wire (M1) (green or bare copper), connect the fixture's ground wire to it. Otherwise, connect the fixture's ground wire directly to the back plate (D1) using the green screw (E1) provided. After wires are connected, tuck them carefully inside the junction box.
5. Secure mounting backplate (D1) to the junction Box (F1) using junction box screws (B1).The side of the mounting backplate marked "GND" (E1) must face out.
6. Secure the mounting backplate (D1) to wall using the screws (I1) and the plastic anchors (R1).
7. Connect the fixture's wires (Blue & Red), the Blue to the transformer's wire (Blue) and the other Red to the transformer's wire (Red). ***Requires Transformer to be recessed within the junction box**

8. Place the fixture's canopy plate (L1) over the mounting back plate (D1) and secure with screws (C1).
9. Place the glass holder (H1) into glass (G1) secure with washer (PP/QQ) and nut (O1). Or place the glass holder (H1) into metal shield (N1) and glass (G1) secure with washer(PP/QQ) and nut(O1).
10. Slide the glass (G1) into the canopy plate (L1) and secure with the set screws (C1).

11. User can make adjustments by tightening/ loosening mounting screws "CC" on both sides to center the canopy plate between the glass holders.

Fig.2 Wiring

Fixture Wires Black or Smooth	House Wires Black (Hot)
Fixture Wires White or Ribbed	House Wires White (Neutral)
Fixture Wires Bare wire (Ground)	House Wires Green or Bare Copper (Ground)

Modern Forms
www.modernforms.com
Phone (800) 526.2588 • Fax (800) 526.2585

Headquarters/Eastern Distribution Center
44 Harbor Park Drive • Port Washington, NY 11050
Phone (516) 515.5000 • Fax (516) 515.5050

Western Distribution Center
1750 Archibald Ave • Ontario, CA 91761
Phone (800) 526.2588 • Fax (800) 526.2585

